

The New Standard in High Power Redundant
Microwave Amplifier Systems Has Arrived



**4kW C Band Solid State High Power Amplifier System
configured with (8) Modules**

FEATURES

- Output Power levels of:
 - > 7.0 kW in C-Band
 - > 6.0 kW in X-Band
 - > 3.0 kW in Ku-Band
- No Active Switching-All Passive Power Combining
- System is 100% field maintainable
- Output Power sized for n+1 Redundancy
- All active modules are hot swappable via the front or rear panels
- System can be configured with any combinations of 4 to 16 modules.
- Hot Swappable Redundant Power Supply Modules
- Hot Swappable SSPA Modules
- Removable Fan Trays
- Removable M&C Card Assembly
- System monitor and control emulates single SSPA Chassis operation
- Ethernet Port with UDP,SNMP, and internal web browser capability
- Legacy RS485 M&C
- Accurate Output Power Measurement
- Reflected Power Monitor
- RF Output Sample Port (-50 dB)
- RF Gain Adjustment (50 dB - 70 dB)
- System is field scalable: i.e., can start out with (4) modules in system and upgrade to (8) or (16) modules.

PowerMAX is covered by U.S. Patent No. 8,189,338 B2

Modular N+1 Soft-Fail Phase Combined System

System Configurations and Soft-Fail Output Power



**(8) Module System with 600W C Band Chassis
 Single cabinet system [31RU]**

Number of Modules in System	System Output Power, Psat dBm (Watts)	Reduction in Output Power (dB)
8	66.0 dBm (3981 W)	0
7	64.8 dBm (3020 W)	-1.2
6	63.6 dBm (2291 W)	-2.4
5	62.0 dBm (1585 W)	-4.0
4	60.0 dBm (1000 W)	-6.0
3	57.5 dBm (562 W)	-8.5

(8) Module, 4kW C-Band System comprised of (8) 600W C Band modules



**(16) Module System with 300W C Band Chassis
 Dual cabinet system [62RU]**

Number of Modules in System	System Output Power, Psat dBm (Watts)	Reduction in Output Power (dB)
16	65.4 dBm (3467 W)	0
15	64.8 dBm (3020 W)	-0.6
14	64.2 dBm (2630 W)	-1.2
13	63.4 dBm (2188 W)	-2.0
12	62.9 dBm (1950 W)	-2.5
11	62.4 dBm (1738 W)	-3.0

(16) Module, 4kW C-Band System comprised of (16) 300W C-Band modules



System Operation

The PowerMAX system maintains complete parallel redundancy down to the embedded control level. Therefore the loss of an entire HPA chassis will not interrupt remote communications with the system. Remote communications can be either RS-485 or Ethernet. The system will automatically correct its gain level in the event of one or more HPA chassis failures.

The sophisticated system monitor and control allows the system to be locally or remotely operated as if it were a “single” chassis amplifier. The system control maintains a hierarchical management that allows the operator to interface to a single chassis of the multi-module array.

Another feature unique to Paradise Datacom’s PowerMAX is the introduction of “true rms” output power measurement. Unlike other amplifier systems that utilize diode detection schemes, the PowerMAX reports the true rms output power of the system independent of the number of carriers and modulation schemes.

Proprietary waveguide combining techniques are employed so that maximum power combining efficiency is optimized within the operating frequency band.

System Output Power and Configurations

Because the system power combining is purely passive and no switching is used, there is never an interruption in RF output power. The PowerMAX system is typically used as a “self-redundant” system. The output power is sized such that the loss of (1) RF module’s power will still allow the system to maintain its minimum required output power. This type of system architecture is described as n+1 redundant. The system can be configured with any number of modules but best overall efficiency is obtained with the popular binary combinations of 4, 8, or 16 modules. It is very easy to upgrade the PowerMAX system from 4 modules to 8 or 16 modules in the field. It is not necessary to fully populate the system at the time of initial purchase. This provides the user a path to upgrade output power capability as system requirements grow, thus keeping capital investment minimized. For sizing redundant output power capability use the following guideline to determine the output power of the system with the loss of (1) module.

4 Module System - 3 of 4 Modules Operable = 2.5 dB loss in output power capability

8 Module System - 7 of 8 Modules Operable = 1.2 dB loss in output power capability

16 Module System - 15 of 16 Modules Operable = 0.6 dB loss in output power capability

System Prime Input Power

Proprietary adaptive bias techniques are utilized to achieve an aggressive balance between RF output power and minimized DC input power.

Prime power may be introduced into a terminal block at the top of the cabinet. Electrical conduit is routed between the terminal block and a 5RU boxed assembly, the AC Distribution/Circuit Breaker Panel, which houses a separate toggle switch circuit breaker for each power supply module in the system. Additional circuit breakers are available for auxiliary equipment mounted in the cabinet.

System prime input power is achieved with an array of modular (hot-swap) power supply chassis. Power is distributed from the power supplies to the SSPA modules via a bus rail assembly.

Each of the power supply modules has its own single phase, 180-264 VAC input. This makes it very convenient to parallel the AC inputs of two modules and connect the array to a three phase AC input source.

The power supply chassis is configured as a n+1 redundant, hot swappable power supply. In the event of a power supply module failure, the amplifier system will not fail. The failed module can be changed without ever taking the HPA out of service. The microwave amplifier architecture is also designed for maximum soft fail redundancy.

Prime system AC Input Power specifications are shown on pages 7-9 for various PowerMAX power levels and configurations.



Terminal Block

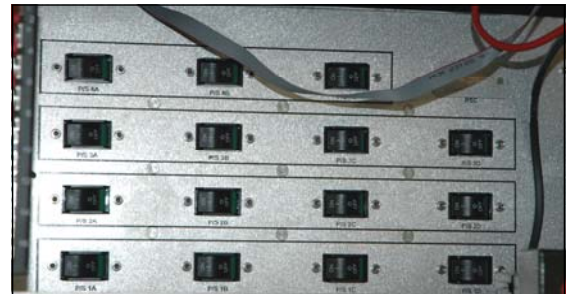

Circuit Breaker Panel



Power Supply Module in Chassis



Quick Connect Plug into Bus Rail

Modular N+1 Soft-Fail Phase Combined System

Hitless Redundancy

For mission critical systems in which no power outage can be tolerated, an eight module PowerMAX system can be operated with only four modules installed. In this way, the additional four modules can be installed without requiring the system to be powered off.

The only disadvantage of operating the eight module PowerMAX system with four modules is the additional 3 dB loss that the four module (half-system) system experiences by going through the final hybrid combiner as shown at right. Therefore the overall output power is actually 6 dB below what it would be with all eight modules present in the system.

If, however, the module output power is sized such that this reduction in output power can be tolerated, the system shown at right is an effective means of scaling the system from four to eight modules and maintaining true hitless operation. The system never has to be powered down and there are no mechanical switches involved that would create an interruption of service.

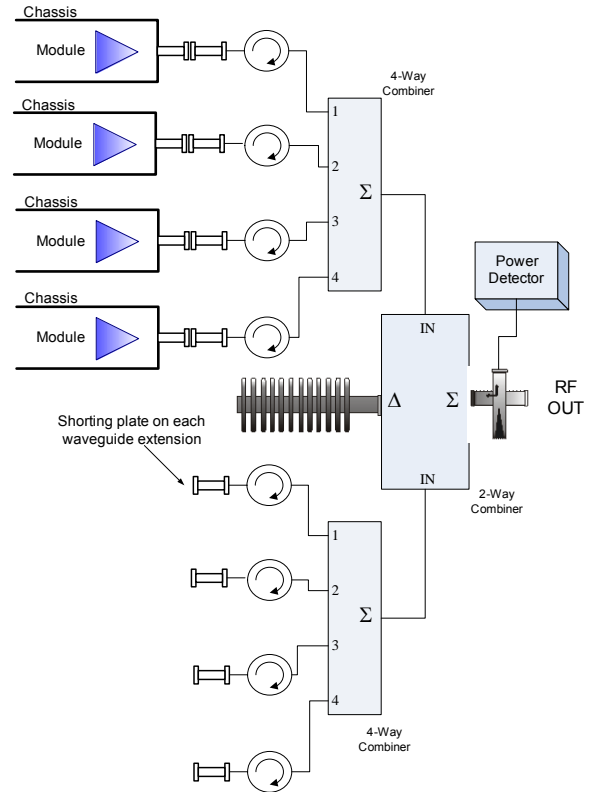

With parallel system architectures, the amplifier output power capability and gain will change as the number of active modules vary. The PowerMAX system is designed with an Auto-Gain Control mode so that the overall system gain will remain constant in the event of a single module failure. See the table below.

System Type	# Modules in System	Gain Change Auto Gain Control On	Gain Change Auto Gain Control Off	Maximum Output Power
4-Chassis	3 of 4	0 dB	-2.5 dB	-2.5 dB
4-Chassis	2 of 4	-1.0 dB	-6.0 dB	-6.0 dB
4-Chassis	1 of 4	-7.0 dB	-12.0 dB	-12.0 dB
8-Chassis	7 of 8	0 dB	-1.2 dB	-1.2 dB
8-Chassis	6 of 8	0 dB	-2.5 dB	-2.5 dB
8-Chassis	5 of 8	0 dB	-4.0 dB	-4.0 dB
8-Chassis	4 of 8	-1.0 dB	-6.0 dB	-6.0 dB
8-Chassis	3 of 8	-3.5 dB	-8.5 dB	-8.5 dB
8-Chassis	2 of 8	-7.5 dB	-12.5 dB	-12.5 dB
16-Chassis	15 of 16	0 dB	-0.6 dB	-0.6 dB
16-Chassis	14 of 16	0 dB	-1.2 dB	-1.2 dB
16-Chassis	13 of 16	0 dB	-2.0 dB	-2.0 dB
16-Chassis	12 of 16	0 dB	-2.5 dB	-2.5 dB

Modular N+1 Soft-Fail Phase Combined System

SSPA Chassis Population Options

The PowerMAX system is available in a variety of system module configurations and output power levels. The system is based on Paradise Datacom's 3RU chassis with 100% hot swappable active assemblies. The units can be configured with a wide variety of SSPA frequency bands and power levels, and can be fitted with the following SSPA modules:

- **C Band:** 100W, 140W, 200W, 250W, 300W, 400W, 500W and 600W
- **X Band:** 250W, 350W and 500W
- **Ku Band:** 50W, 70W, 100W, 125W, 200W and 250W



Hot-Swap Chassis Features

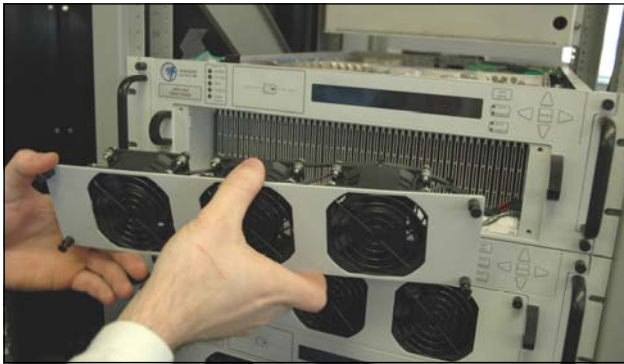

Removable front panel fan tray

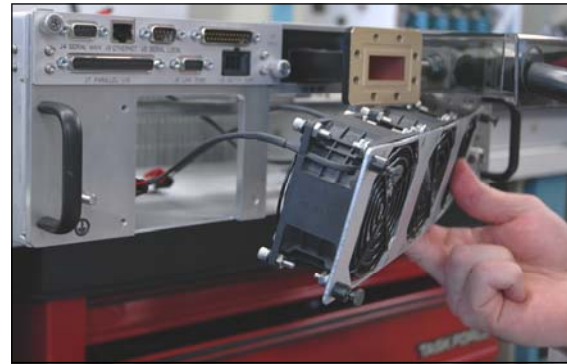

Removable rear panel fan tray



Removable rear panel monitor and control card

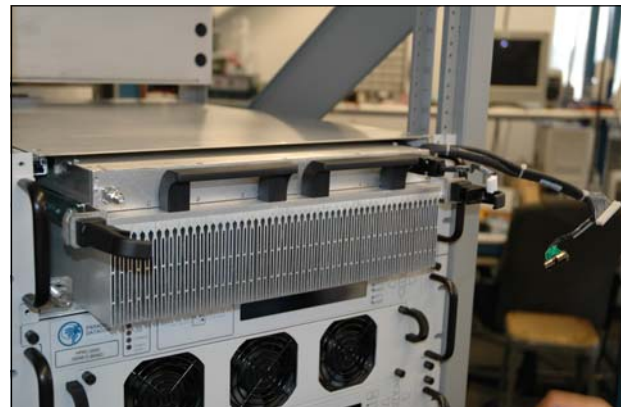

SSPA Module Removal via the front panel

Modular N+1 Soft-Fail Phase Combined System

4 SSPA Module System Output & Redundant Power

SSPA Module Power Level	Maximum Output Power 4 modules P_{sat} dBm (W)	Maximum Output Power 4 modules P_{1dB} dBm (W)	Prime AC Input Power @ P_{1dB}	Redundant Output Power, 3 modules P_{sat} dBm (W)	Redundant Output Power, 3 modules P_{1dB} dBm (W)
C-Band					
100W	55.2 (331)	54.7 (295)	3,588 W	52.8 (191)	52.3 (170)
140W	56.7 (468)	56.2 (417)	3,974 W	54.3 (269)	53.8 (240)
200W	58.2 (661)	57.5 (562)	5,244 W	55.8 (380)	55.1 (324)
250W	59.2 (832)	58.2 (661)	5,520 W	56.8 (479)	55.8 (380)
300W	60.0 (1000)	59.2 (832)	7,542 W	57.5 (562)	56.8 (479)
400W	61.2 (1318)	60.2 (1047)	9,825 W	58.8 (759)	57.8 (603)
500W	62.2 (1660)	61.2 (1318)	11,592 W	59.8 (955)	58.8 (759)
600W	63.0 (1995)	62.2 (1660)	14,904 W	60.6 (1148)	59.8 (955)
X-Band					
250W	59.2 (832)	58.5 (708)	8,004 W	56.8 (479)	56.1 (407)
350W	60.7 (1175)	59.7 (933)	10,874 W	58.3 (676)	57.3 (537)
500W	62.2 (1660)	61.2 (1318)	14,904 W	59.8 (955)	58.8 (759)
Ku-Band					
50W	52.2 (166)	51.2 (132)	3,146 W	49.8 (96)	48.8 (76)
70W	53.7 (234)	52.7 (186)	3,312 W	51.3 (135)	50.3 (107)
100W	55.2 (331)	54.2 (263)	4,857 W	52.8 (191)	51.8 (151)
125W	56.2 (417)	55.2 (331)	5,188 W	53.8 (240)	52.8 (191)
200W	58.2 (661)	57.2 (525)	9,000 W	55.8 (380)	54.8 (302)
250W	59.2 (832)	58.2 (661)	9,825 W	56.8 (479)	55.8 (380)

4 Module Systems have 2.5 dB soft-fail redundancy

Modular N+1 Soft-Fail Phase Combined System

8 SSPA Module System Output & Redundant Power

SSPA Module Power Level	Maximum Output Power 8 modules P_{sat} (typical) dBm (W)	Maximum Output Power 8 modules P_{1dB} (minimum) dBm (W)	Prime AC Input Power @ P_{1dB}	Redundant Output Power, 7 modules P_{sat} (typical) dBm (W)	Redundant Output Power, 7 modules P_{1dB} (minimum) dBm (W)
C-Band					
100W	58.0 (631)	57.5 (562)	7,176 W	56.8 (479)	56.3 (427)
140W	59.5 (891)	59.0 (794)	7,948 W	58.3 (676)	57.8 (603)
200W	61.0 (1259)	60.3 (1072)	10,488 W	59.8 (955)	59.1 (813)
250W	62.0 (1585)	61.0 (1259)	11,040 W	60.8 (1202)	59.8 (955)
300W	62.7 (1862)	62.0 (1585)	14,094 W	61.5 (1413)	60.8 (1202)
400W	64.0 (2512)	63.0 (1995)	19,651 W	62.8 (1905)	61.8 (1514)
500W	65.0 (3162)	64.0 (2512)	23,184 W	63.8 (2399)	62.8 (1905)
600W	66.0 (3981)	65.0 (3162)	29,808 W	64.8 (3020)	64.0 (2512)
X-Band					
250W	62.0 (1585)	61.3 (1349)	16,008 W	60.8 (1202)	60.1 (1023)
350W	63.5 (2239)	62.5 (1778)	21,748 W	62.3 (1698)	61.3 (1349)
500W	65.0 (3162)	64.0 (2512)	29,808 W	63.8 (2399)	62.8 (1905)
Ku-Band					
50W	55.0 (316)	54.0 (251)	6,292 W	53.8 (240)	52.8 (191)
70W	56.5 (447)	55.5 (355)	6,624 W	55.3 (339)	54.3 (269)
100W	58.0 (631)	57.0 (501)	9,715 W	56.8 (479)	55.8 (380)
125W	59.0 (794)	58.0 (631)	10,377 W	57.8 (603)	56.8 (479)
200W	61.0 (1259)	60.0 (1000)	18,500 W	59.8 (955)	58.8 (759)
250W	62.0 (1585)	61.0 (1259)	19,651 W	60.8 (1202)	59.8 (955)

8 Module Systems have 1.2 dB soft-fail redundancy

Modular N+1 Soft-Fail Phase Combined System

16 SSPA Module System Output & Redundant Power

SSPA Module Power Level	Maximum Output Power 16 modules P_{sat} (typical) dBm (W)	Maximum Output Power 16 modules P_{1dB} (minimum) dBm (W)	Prime AC Input Power @ P_{1dB}	Redundant Output Power, 15 modules P_{sat} (typical) dBm (W)	Redundant Output Power, 15 modules P_{1dB} (minimum) dBm (W)
C-Band					
100W	60.7 (1175)	60.2 (1047)	14,352 W	60.1 (1023)	59.6 (912)
140W	62.2 (1660)	61.7 (1479)	13,000 W	61.6 (1445)	61.1 (1288)
200W	63.7 (2344)	63.0 (1995)	15,000 W	63.1 (2042)	62.4 (1738)
250W	64.8 (3020)	63.7 (2344)	22,100 W	64.1 (2570)	63.1 (2042)
300W	65.4 (3467)	64.8 (3020)	24,800 W	64.8 (3020)	64.1 (2570)
400W	66.7 (4677)	65.7 (3715)	45,120 W	66.1 (4074)	65.1 (3236)
500W	67.7 (5888)	66.7 (4677)	58,800 W	67.1 (5129)	66.1 (4074)
600W	68.5 (7079)	67.7 (5888)	60,800 W	67.9 (6166)	67.1 (5129)
X-Band					
250W	64.7 (2951)	64.0 (2512)	32,000 W	64.1 (2570)	63.4 (2188)
350W	66.2 (4169)	65.2 (3311)	40,000 W	65.6 (3631)	64.6 (2884)
500W	67.7 (5888)	66.7 (4677)	60,000 W	67.1 (5129)	66.1 (4074)
Ku-Band					
50W	57.7 (589)	56.7 (468)	13,504 W	57.1 (513)	56.1 (407)
70W	59.2 (832)	58.2 (661)	15,360 W	58.6 (724)	57.6 (575)
100W	60.7 (1175)	59.7 (933)	21,600 W	60.1 (1023)	59.1 (813)
125W	61.7 (1479)	60.7 (1175)	22,080 W	61.1 (1288)	60.1 (1023)
200W	63.7 (2344)	62.7 (1862)	36,096 W	63.1 (2042)	62.1 (1622)
250W	64.7 (2951)	63.7 (2344)	38,400 W	64.1 (2570)	63.1 (2042)

16 Module Systems have 0.6 dB soft-fail redundancy

Modular N+1 Soft-Fail Phase Combined System

General Electrical Specifications

PARAMETER	NOTES	LIMITS	UNITS
Gain	Range (Auto-Gain Off)	50 to 70	dB
	Range (Auto-Gain On)	45 to 65	dB
Gain Flatness	full band	± 1.0	dB
Gain Slope	per 40 MHz	± 0.3	dB/40 MHz
Gain Variation vs. Temperature	0 °C to + 50 °C	± 1.0	dB
Gain Adjustment	0.1 dB resolution	20	dB
Intermodulation Distortion	3 dB back off relative to P _{1dB}	-25	dBc
AM/PM Conversion	(@ rated P _{1dB})	3.5	°/dB
	(@P _{1dB} - 3 dB)	1.0	°/dB
Spurious	(@ rated P _{1dB})	-65	dBc
Harmonics	(@ rated P _{1dB} - 3 dB)	-50	dBc
Input VSWR		≤ 1.30 : 1	
Output VSWR		≤ 2.00 : 1	
Noise Figure	at maximum gain	12	dB
Group Delay	Linear	0.01	ns/MHz
	Parabolic	0.003	ns/MHz ²
	Ripple	1.0	ns p-p
Noise Output	TX Band	-75	dBW/4 KHz
	RX Band (C-Band, without filter)	-155	dBW/4 KHz
	RX Band (X-Band, without filter)	-85	dBW/4 KHz
	RX Band (X-Band, with filter)	-155	dBW/4 KHz
	RX Band (Ku-Band, without filter)	-85	dBW/4 KHz
	RX Band (Ku-Band, with filter)	-155	dBW/4 KHz
Residual AM Noise	0 - 10 KHz	-45	dBc
	10 KHz - 500 KHz	-20 (1.25 + log F)	dBc
	500 KHz - 1 MHz	-80	dBc
Residual Phase Noise	Offset frequency from carrier		
	10 Hz	-90	dBc/Hz
	100 Hz	-100	dBc/Hz
	1 KHz	-110	dBc/Hz
	10 KHz	-120	dBc/Hz
	100 KHz	-125	dBc/Hz
	1 MHz	-130	dBc/Hz
RF Leakage	@1m, with SSPA module removed	< 0.001	mW/cm ²

Environmental Specifications

Operating Temperature	Ambient	0 to +50	°C
Relative Humidity	non-condensing	95	%
Cooling System	Integrated, forced air	137	CFM
Audible Noise ¹	per chassis	71	dBA

¹ Audible noise is measured with the fans set at low. Add 3 dBA to the system audible noise figure (low fan) if using the cabinet rear exhaust impellers.

Modular N+1 Soft-Fail Phase Combined System

System Outline Drawing

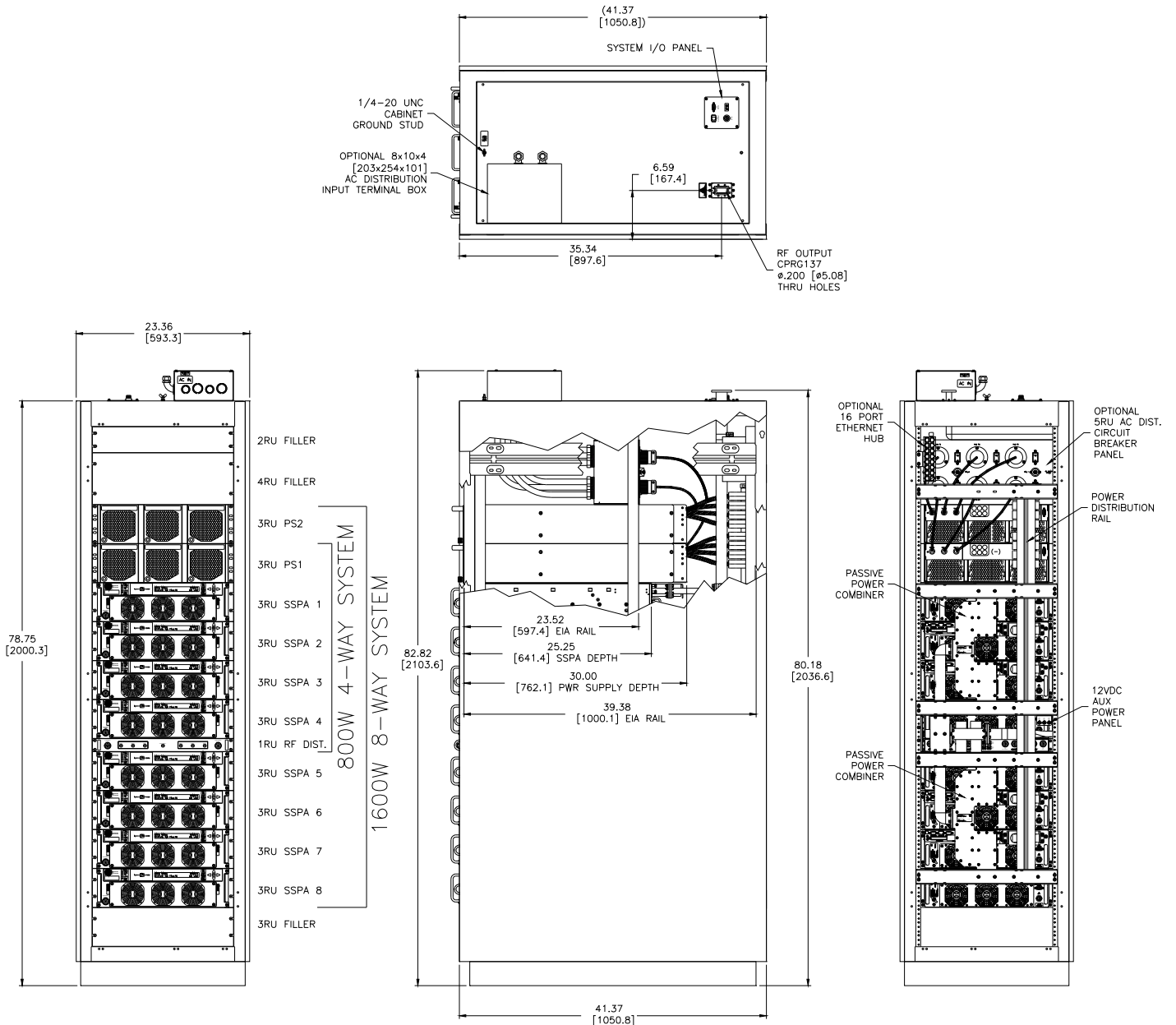

The system pictured above is typical for a 4 kW 8-Module C-Band system.

Note that certain power levels require a different power supply configuration. Consult with the factory for details on your system's prime power requirements.

Modular N+1 Soft-Fail Phase Combined System

System Outline Drawing, with Cabinet Exhaust Option

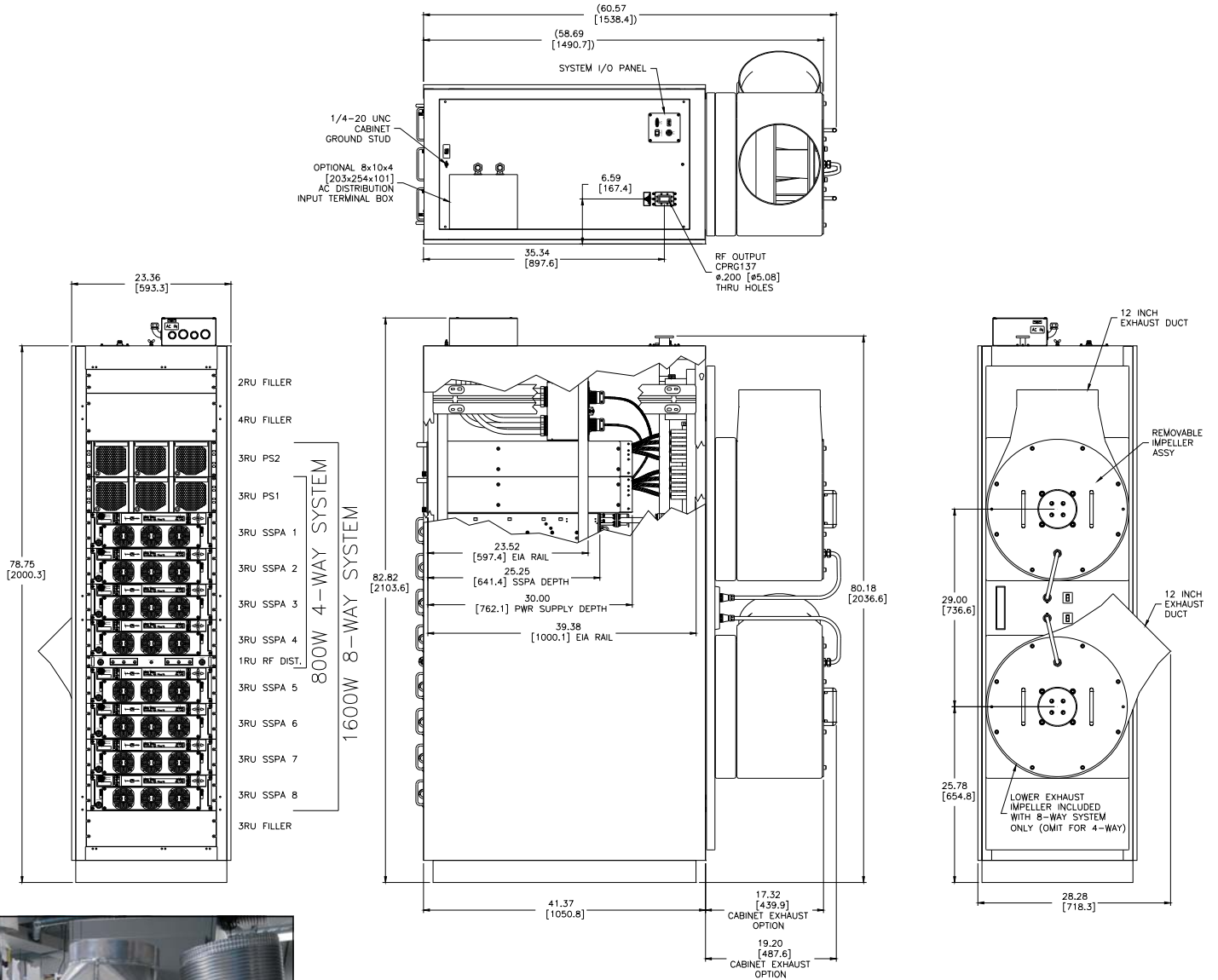

The PowerMAX system is available with an optional cabinet exhaust system, which includes a rear door for the cabinet and an impeller assembly for each grouping of four (4) SSPA chassis in the system.

Power is provided from the AC Distribution Box to the circuit-interruptible power connectors in the interior of the rear door. Separate power cables connect from the outer door couplers to each impeller.

Modular N+1 Soft-Fail Phase Combined System

Spare Module/Chassis Part Number Configuration

H P A [] [] [] [] [] [] [] [] [] [] [] [] **X X X X X**

Band	
C-Band	CC
X-Band	XX
Ku-Band	KU

Module Configuration	
M	SSPA Module
C	Single SSPA Chassis

Chassis Power Level (in Watts)	
Band	Output Power
C	100, 140, 200 250, 300, 400, 500, 600
X	250, 350, 500
Ku	050, 070, 100, 125, 200, 250

Frequency Sub Band	
C-Band	
5.850 - 6.425 GHz	A
5.850 - 6.725 GHz	B
5.750 - 6.670 GHz	C
6.425 - 6.725 GHz (Palapa)	E
6.725 - 7.025 GHz (Insat)	F
5.750 - 6.475 GHz	G
X-Band	
7.90 - 8.40 GHz	A
7.50 - 8.50 GHz	B
7.70 - 8.40 GHz	D
7.75 - 8.50 GHz	E
Ku-Band	
14.00 - 14.50 GHz	A
13.75 - 14.50 GHz	B

! Use this page if ordering a spare SSPA module or single SSPA Chassis for a PowerMAX System.

EXAMPLES:

250W C-Band PowerMAX Spare SSPA Module:
 250W C-Band PowerMAX Spare Single Chassis:

HPACC250AMXXXXX
 HPACC250ACXXXXX

Modular N+1 Soft-Fail Phase Combined System

System Part Number Configuration

Module Configuration				Cabinet Option	
F	Four (4) SSPA Chassis			Y	With Cabinet
E	Eight (8) SSPA Chassis			Z	With Cabinet & Exhaust System (1 exhaust impeller per 4 SSPA Chassis)
S	Sixteen (16) SSPA Chassis				

Band	
C-Band	CC
X-Band	XX
Ku-Band	KU

ENTER THE
 SINGLE CHASSIS
 POWER LEVEL

Configuration Modifier 3	
X	Standard
E	Ethernet Switch

Chassis Power Level (in Watts)				
Band	System Total Power (# chassis)			Single Chassis
	(4) - "F"	(8) - "E"	(16) - "S"	
C	331 W	631 W	1175 W	100
	468 W	891 W	1660 W	140
	661 W	1259 W	2344 W	200
	832 W	1585 W	3020 W	250
	1000 W	1862 W	3467 W	300
	1318 W	2512 W	4677 W	400
	1660 W	3162 W	5888 W	500
	1995 W	3981 W	7079 W	600
X	832 W	1585 W	2951 W	250
	1175 W	2239 W	4169 W	350
	1660 W	3162 W	5888 W	500
Ku	166 W	316 W	589 W	050
	234 W	447 W	832 W	070
	331 W	631 W	1175 W	100
	417 W	794 W	1479 W	125
	661 W	1259 W	2344 W	200
	832 W	1585 W	2951 W	250

Configuration Modifier 2	
X	Standard
R ¹	RX Band Reject Filter

¹ X-Band and Ku-Band only

Configuration Modifier 1	
X	Standard

AC Distribution	
X	None
A	Input Terminal Block; Circuit Breaker Panel

Frequency Sub Band	
C-Band	
5.850 - 6.425 GHz	A
5.850 - 6.725 GHz	B
5.750 - 6.670 GHz	C
6.425 - 6.725 GHz (Palapa)	E
6.725 - 7.025 GHz (Insat)	F
5.750 - 6.475 GHz	G
X-Band	
7.90 - 8.40 GHz	A
7.50 - 8.50 GHz	B
7.70 - 8.40 GHz	D
7.75 - 8.50 GHz	E
Ku-Band	
14.00 - 14.50 GHz	A
13.75 - 14.50 GHz	B

EXAMPLE: 1800 W C-Band PowerMAX System - (8) 250 W SSPA Chassis, with cabinet and exhaust, AC distribution and Ethernet switch: **HPACC250AEZAXXE**

Use and Disclosure of Data: The items described herein are controlled by the U.S. Government and authorized for export only to the country of ultimate destination for use by the ultimate consignee or end-user(s) herein identified. They may not be resold, transferred, or otherwise disposed of, to any other country or to any person other than the authorized ultimate consignee or end-user(s), either in their original form or after being incorporated into other items, without first obtaining approval from the U.S. government or as otherwise authorized by U.S. law and regulations.

Proprietary and Confidential: The information contained in this document is the sole property of Teledyne Paradise Datacom. Any reproduction in part or as a whole without the written permission of Teledyne Paradise Datacom is prohibited.

Specifications are subject to change without notice.